



DynaDry 
FOOD

TECHNICAL DATA



ANTI -DRIP



WATER DISCHARGE



WASHABLE



HIGH SAFETIES



SELF-REPAIR



OIL FREE



GRAVITY TECHNOLOGY

MAXIMUM DIMENSIONS	W 4000 mm x H 4000 mm
SPEED	Max opening speed up to 2,5 m/s
	Closing speed adjustable 0,8 m/s
CYCLES TEST	1.000.000
AIR PERMEABILITY	Standard Class 2 Optional Class 5 with <i>patented magnetic system</i>
STRUCTURE	Not self-supporting
FRAME / MOTOR COVER HOOD	Standard Galvanized Steel
	Optional • Powder coated Steel • Stainless Steel 441/316
CURTAIN	Standard PVC curtain 900 gr/m ²
	Optional • Insulated 7mm, 3.3 W/m ² K • Translucent 35/40% • FDA (white) • Antistatic
SLIDING SYSTEM <i>lubrication-free</i>	Patented sliding system with high density Polyzene self-lubricant equipped of sliding zipper directly on curtain
CONTROL PANEL	Standard Powder coated steel box IP54 (300 x 500 x 150 mm)
	Optional • Stainless Steel • PVC box IP65 (300 x 400 x 150 mm)
	Inverter system 50/60 Hz with absolute encoder
	Power supply 1-ph, 230V max 16A
	Power supply 3-ph, 400V max 10A
	Power supply 3-ph, 230V max 16A
	Start/Stop Button
	2 free contacts (door open/ closed/ alert)
	Automatic/ Manual Interlocking between 2 doors
	IP rating for motor and control panel IP54*
WIRING	Plug and Play system IP65
SAFETIES	Standard • Photocells set IP65 • Anti-jam sensor reverse • WiFi safety edge IP65
	Optional Multi ray light curtain barrier H2500 IP67
EMERGENCY OPENING	Standard Mechanical key Optional UPS battery
ADVISING OPERATIVE TEMPERATURE	Operating till - 10°C * with heating kit added - Not apt to be installed in negative/positive temperature

The **DYNAMICROLL® DynaDry** features a stainless steel construction and is designed to prevent condensation and water from falling into the passageway when the door is open. The door, with its patented and innovative system, protects the goods passing under the passageway and is designed to be easily washable in all its parts while meeting the hygiene criteria required by the industry.

EN13241 CERTIFICATION

STANDARD	RIF.	TEST ACC.	RESULTS
WATER PERMEABILITY	EN 12425	EN 12489	Class 1
WIND LOAD	EN 12424	EN 12444	Class 3
WIND PERMEABILITY	EN 12426	EN 12427	Class 2
			Class 5 with patented magnetic system
SAFE OPENINGS	EN 12453	EN 12445	✓
MECHANICAL RESISTANCE	EN 12604	EN 12605	✓
UNINTENDED MOVEMENTS	EN 12604	EN 12605	✓
THERMAL TRANSMITTANCE	EN 12428	EN 12428	6,02 W/m ² K
PERFORMANCE (CYCLES)	EN 12604	EN 12605	1.000.000

Values can change depending on door dimensions

ADVANTAGES

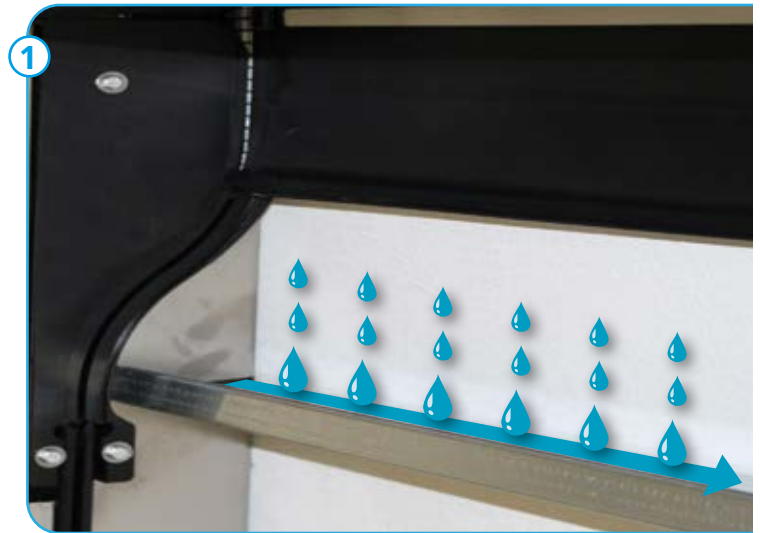

- Patented system
- Anti-drip

- Hygienic
- Fast
- Hermetic
- Silent
- 100% safe with no rigid elements in the mantle
- Plug & Play (ease of installation)
- Low maintenance
- Energy-saving
- Easily washable
- Self-repairing

SLIDING SYSTEM / SELF-REPAIRING



DOOR SPACE REQUIREMENTS

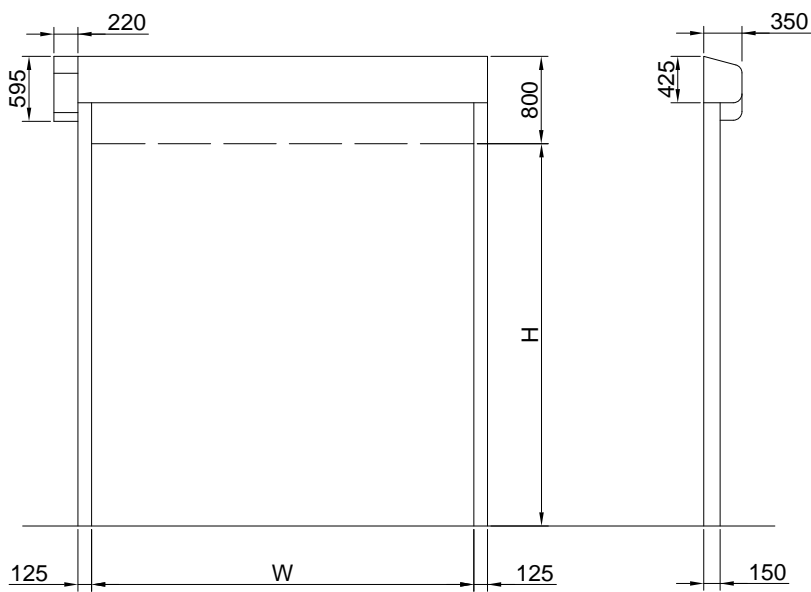
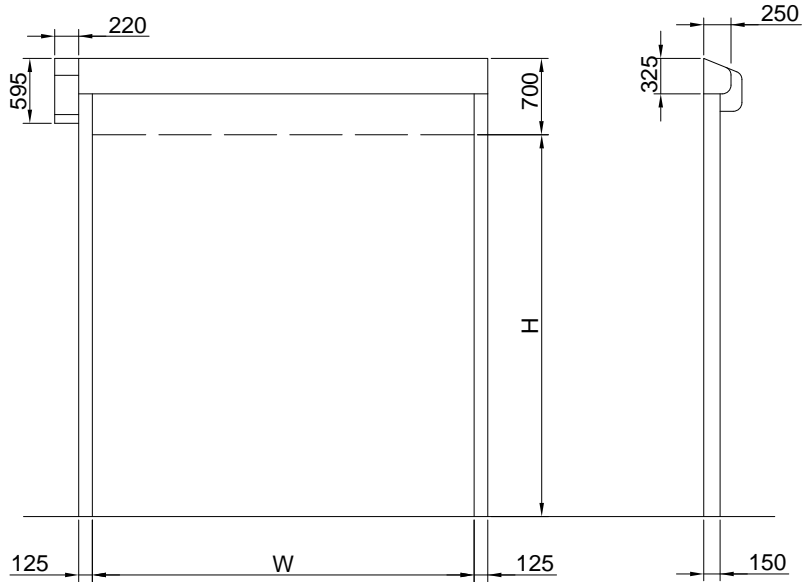

FIXING DETAILS

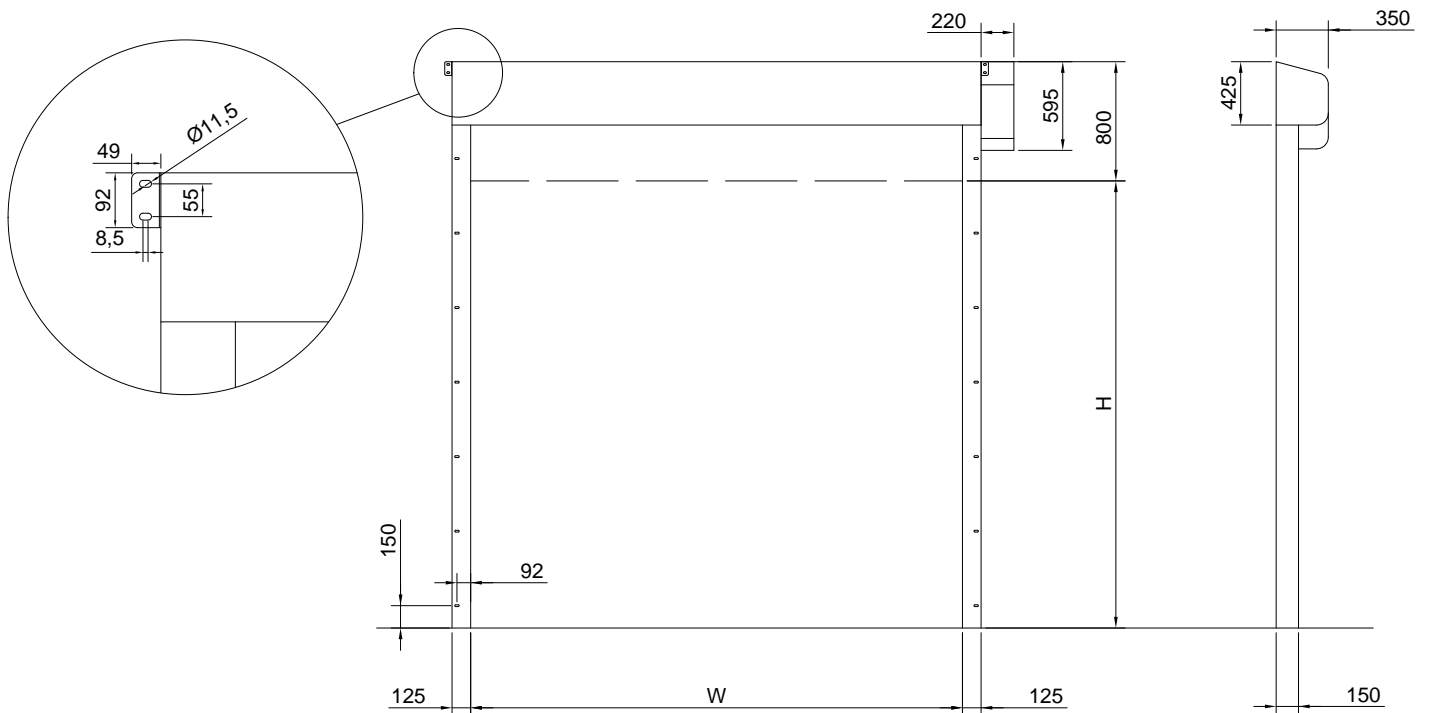

PVC CHARACTERISTICS

STANDARD PVC

Composition and tests

EXTERNAL SIDE			
Material	Finishing	Color	Thick
PVC	Opaque	12 standard	0,7 mm
FABRIC			
Material	N. tarps	Title	EN 2286-2
PES	1	1100Dtex 12x12	900 g/m ²
INTERNAL SIDE			
Material	Finishing	Color	Thick
PVC	Rough	12 standard	0,2 mm
COLD RESISTANCE ISO 4675/90 -50°C ±5			
HYDROLYSIS TEST 75°C 95% humidity none variation			
GAS OIL TEST ISO 1421 none variation			
MARINE WATER TEST (ISO 1421) none variation			
OZONE TEST ISO 3011 none crack			
T. STORAGE (°C) -30 +65			
FLAME TEST (ISO 3795) < 100 mm/min			
PERFORATION RINA 3.A1.2.7 (N) > 100			
EXERCISE 7 days -70°C ISO 6065 none variation			

Characteristics

THICK ISO 2286/3 (mm) 0,9±0,1
WEIGHT ISO 2286/2 (kg/m ²) 0,90±0,1
LOAD BREAK ISO 1421 6000 N/50mm
WARP EXTENSION ISO 1421 4300 N/50mm
TEXTURE EXTENSION ISO 1421 4000 N/50mm
WARP BREAK dIN 53 363 (N) > 600
TEXTURE BREAK dIN 53 363 (N) > 530
ADHESION dIN EN ISO 2411 130 N/50mm
EEC CONFORMITY Yes
SPECIFIC USE industry, refrigerators, car washes, supermarkets, warehouses
ASSOCIATION -

Colors

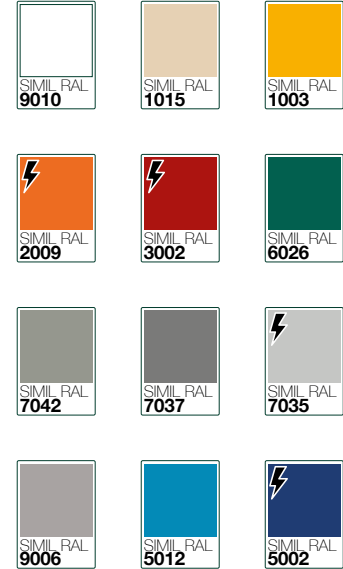

⚡ Antistatic available

INSULATED PVC

Composition and tests

EXTERNAL SIDE			
Material	Finishing	Color	Thick
PVC	Straight	4 standard	0,5 mm
FABRIC			
Material	N. tarps	Title	EN 2286-2
PES	1	1100Dtex 12x12	1350 g/m ²
INTERNAL SIDE			
Material	Finishing	Color	Thick
PVC	Sponge	4 standard	7 mm
COLD RESISTANCE ISO 4675/90 -10°C ±5			
HYDROLYSIS TEST 75°C 95% humidity none variation			
GAS OIL TEST ISO 1421 none variation			
MARINE WATER TEST (ISO 1421) none variation			
OZONE TEST ISO 3011 none crack			
T. STORAGE (°C) -30 +65			
FLAME TEST ISO 3795 cl 2, NFPA 701 test 2			
PERFORATION RINA 3.A1.2.7 (N) > 100			
EXERCISE 7 days -70°C ISO 6065 none variation			

Characteristics

THICK ISO 2286/3 (mm) 7,0±0,1
WEIGHT ISO 2286/2 (kg/m ²) 1,7±0,1
LOAD BREAK ISO 1421 6000 N/50mm
WARP EXTENSION ISO 1421/V1 3000 N/50mm
TEXTURE EXTENSION ISO 1421/V1 2800 N/50mm
WARP BREAK dIN 53 363 300 N
TEXTURE BREAK dIN 53 363 300 N
ADHESION PA 09.03 (internal) 15 N/cm
THERMAL CONDUCTIVITY 0,03782 W.m ⁻¹
ISOLATION INDEX Rw= 17,5 dB
EMPLOYMENT industry, refrigerators, car washes, supermarkets, warehouses
ASSOCIATION -

Colors

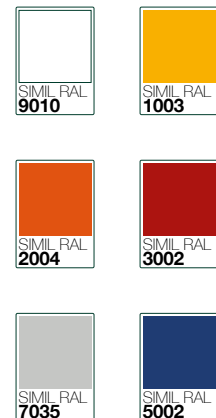

TECNICAL DATA

Composition and tests

TOP FACE COATING			
Material	Finish	Color	Thickness
PUR	Opaque	white	0,6 mm
FABRIC			
Material	N. tarps	Title	EN 2286-2
PET	1	2200 Dtex 12x12	1500 g/m ²
UNDERSIDE COATING			
Material	Finish	Color	Thickness
PUR	Plain	white	0,6 mm
COLD RESISTANCE			
ISO 4675/90 -30°C ±5			
TROPICAL TEST			
75°C 95% humidity none variation			
DIESEL FUEL TEST			
ISO 1421 none variation			
SEA WATER TEST			
ISO 1421 none variation			
OZONE TEST			
ISO 3011 none crack			
T. STORAGE			
(°C) -30 +65			
ABRASION			
ISO 5470/80, 5N C517 400 cycles (mg) 1			
PUNCTURE			
RINA 3.A1.2.7 (N) > 125			
AGEING 7 days -70°C			
ISO 6065 none variation			

Characteristics

THICKNESS	
ISO 2286/3 (mm) 1,20±0,1	
WEIGHT	
ISO 2286/2 (kg/m ²) 1,30±0,1	
TENSILE STRENGTH WARP	
ISO 1421 6000 N / 50mm	
ELONGATION YARN	
ISO 1421 [%] > 14	
ELONGATION WEFT	
ISO 1421 [%] > 20	
TEAR RESISTANCE WARP	
dIN 53 363 (N) > 250	
TEAR RESISTANCE WEFT	
dIN 53 363 (N) > 220	
PEELING TEST	
dIN EN ISO 2411 130 N/50mm	
FDA COMPLIANCE CEE	
Yes	
SPECIFIC USE	
cleanrooms, clinical, hospital	
ASSOCIATION	
DynamicRoll®	

Disclaimer

The information contained in this document describes the features of the BMP EUROPE product as tested in a laboratory, other indications excepted, environment at a temperature of +23 degrees c° at 50% relative humidity. It does not necessarily reflect the conditions of industrial use and it does not guarantee the product to be suitable for certain applications. The client remains liable for the proper selection and correct use of the BMP EUROPE product. BMP EUROPE cannot be held responsible should damages arise from the use of its products. Necessary alterations to this data can be made without prior notice.

CRISTAL CHARACTERISTICS

PVC SUPERCLEAR

WINDOWS - CRISTAL

TECHNICAL DATA

Article SUPERCLEAR 1.2 mm FR

Technical Specifications	Standards	Unit	Values
Thickness	-	mm.	1.2
PVC total weight	-	g/m ²	1200
Ligth transmission	JIS K - 7361	%	97.3
Tensile strength <i>Lenghtwise MD</i>	JIS K - 6732	N	26.1
Tensile strength <i>Crosswise TD</i>	JIS K - 6732	N	24.3
Tear strength <i>Lenghtwise MD</i>	JIS K - 6732	N	63.4
Tear strength <i>Crosswise TD</i>	JIS K - 6732	N	63.9
Elongation <i>Lenghtwise MD</i>	JIS K - 6732	%	377
Elongation <i>Crosswise TD</i>	JIS K - 6732	%	378
Cold crack resistance	JIS K - 6772	°C	-45

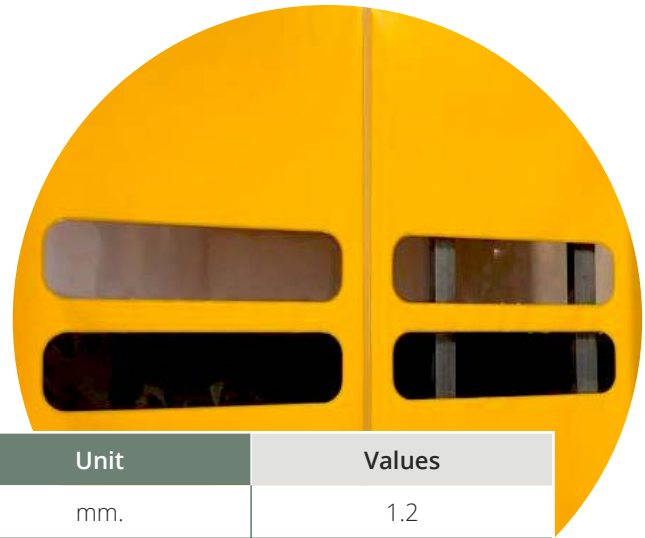

OPTIONAL ACCESSORIES



RADAR



OPENING POINT
RADAR tof/spot
for internal use only



INFRARED RADAR
with cross-movement
adjustment



INFRARED RADAR
motion and presence
(pedestrian/forklift) radar

TRAFFIC LIGHTS



GREEN FIXED STANDARD
traffic light



RED FIXED STANDARD
traffic light



LED TRAFFIC LIGHT
with countdown



LED TRAFFIC LIGHT BARRIERS
(connection card included)

BUTTONS



OPENING GREEN BUTTON
with box



OPENING BLACK BUTTON
with box



FREEZE STOP BUTTON
with box



NO TOUCH BUTTON



TRAFFIC LIGHT BUTTON



WIND GAUGE



KEY SELECTOR



REMOTE CONTROL



BOLLARD B-PROTECT



PULL CORD SWITCH



MAGNETIC LOOP DETECTOR

Quality products since 1997

BMP EUROPE HIGH SPEED DOORS
Strada della Freisa 1 - Villanova d'Asti 14019 (AT)
+39 0141 948843
www.bmpdoors.com - info@bmpeurope.eu

10/2022